

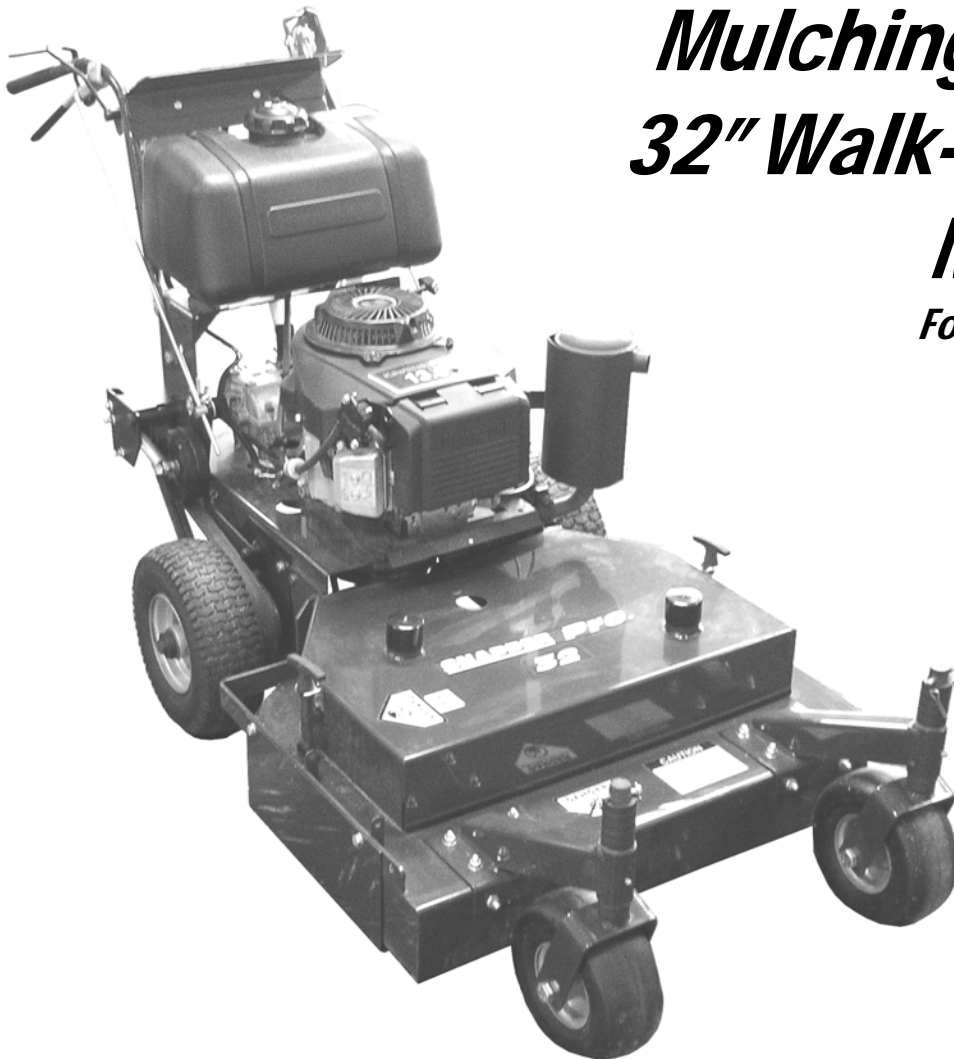

GIANT-VAC



INSTALLATION INSTRUCTIONS
OPERATING INSTRUCTIONS
PARTS LIST



Mulching Kit for 32" Walk-Behind Mowers

***For Walk-Behind
Mower model:
SGV13321KW***

MODEL MK32

Actual product may differ from product pictured above
Mower not included

Kits covered by this manual:
MK32 (for model SGV13321KW)

THIS PAGE INTENTIONALLY BLANK

1 preliminaries

Congratulations!

You have just purchased one of the finest outdoor power equipment accessories on the market today. If properly cared for, your new mulch kit will provide years of dependable service. Please read and follow this instruction manual carefully in order to get the most out of your new equipment.

As you carefully unpack your unit, you will find the following items:

- 2 16" Mulching Blades
- 1 Discharge Cover
- 1 Package containing Discharge Cover Installation Hardware
- 1 Package containing Operating Manual

Each product leaves our factory in excellent condition; occasionally, however, some damage may occur during shipment. If any such damage is found upon initial inspection, *immediately* notify the transport carrier who delivered your machine, as they are solely responsible for such damage, as well as any subsequent adjustments necessary.

Before assembly, please take a moment and record the model number of your mulch kit, and the date purchased, for future reference:

Model number _____

Date Purchased _____

Your new mulch kit requires very little assembly. Simply follow the instructions contained within this manual to begin enjoying the benefits of your new product.

CALIFORNIA PROPOSITION 65 WARNING

Gasoline and Diesel engine exhaust and some of its constituents are known to the State of California to cause cancer, birth defects and other reproductive harm.

As an owner of off-road gasoline or diesel engine equipment and/or as an employer, you also may have an obligation under the California Occupational Safety and Health Act or under Proposition 65 to warn persons exposed to gas and diesel engine exhaust and/or other Proposition 65 chemicals in and around your workplace. See California Health and Safety Code section 25249.5, Title 22 of the California Code of Regulations at Section 1200 *et seq.*, and Title 8 of the California Code of Regulations Section 5194.

R0404.1

2 *safety rules regarding outdoor power equipment*



IMPORTANT! READ CAREFULLY THE FOLLOWING GENERAL SAFETY RULES BEFORE ASSEMBLING OR OPERATING ANY OUTDOOR POWER EQUIPMENT.

TRAINING

- Read, understand, and follow all instructions in the manual and on the unit before starting. If the operator(s) or mechanic(s) can not read English it is the owner's responsibility to explain this material to them.
- Become familiar with the safe operation of the equipment, operator controls, and safety signs.
- All operators and mechanics should be trained. The owner is responsible for training the users.
- Only allow responsible adults, who are familiar with the instructions, to operate the unit.
- Never let children or untrained people operate or service the equipment. Local regulations may restrict the age of the operator.
- The owner/user can prevent and is responsible for accidents or injuries occurring to themselves, other people or property.

PREPARATION

- Evaluate the terrain to determine what accessories and attachments are needed to properly and safely perform the job. Use only accessories and attachments approved by the manufacturer.
- Wear appropriate clothing including safety shoes, safety glasses and ear protection. Long hair, loose clothing or jewelry may get tangled in moving parts.
- Inspect the area where the equipment is to be used and remove all objects such as rocks, toys and wire, which can be thrown by the machine.
- Use extra care when handling gasoline and other fuels. They are flammable and vapors are explosive.
 - a) Use only an approved container.
 - b) Never remove fuel cap or add fuel with the engine running. Allow engine to cool before refueling. Do not smoke.
 - c) Never refuel or drain the machine indoors.
- Check that operator's presence controls, safety switches and shields are attached and functioning properly. Do not operate unless they are functioning properly.

OPERATION

- Never run an engine in an enclosed area.
- Mow only in the daylight or with good artificial light, keeping away from holes and hidden hazards.
- Be sure transmission is in neutral and cutting

blades are disengaged before starting engine.

- Be sure of your footing while using pedestrian controlled equipment, especially when backing up. Walk, don't run.
- Do not mow in reverse unless absolutely necessary. Always look down and behind before and while traveling in reverse.
- Be aware of the mower discharge direction and do not point it at anyone. Do not operate the mower without either the entire grass catcher or the deflector in place.
- Slow down and use caution when making turns and when changing directions on slopes.
- Never raise deck with the blades running.
- Never leave a running unit unattended. Always disengage cutting blades, set transmission in neutral, stop engine, and remove keys before leaving unit. Keep hands and feet away from the cutting units.
- Disengage the cutting blades when not mowing.
- Never operate with guards not securely in place. Be sure all safety features are attached, adjusted properly and functioning properly.
- Never operate with the discharge deflector raised, removed or altered, unless using a grass catcher.
- Do not change the engine governor setting or over speed the engine.
- Stop on level ground, disengage cutting blades, set transmission in neutral, shut off engine before leaving the operator's position for any reason including emptying the grass catchers or unclogging the chute.
- Stop equipment and inspect blades after striking objects or abnormal vibration occurs. Make necessary repairs before resuming operations.
- Keep hands and feet away from the cutting units.
- Never carry passengers and keep pets and bystanders away.
- Do not operate the unit while under the influence of alcohol or drugs.
- Slow down and use caution when making turns and crossing roads and sidewalks. Stop blades if not mowing.
- Use care when loading or unloading the machine into a trailer or truck.
- Use care when approaching blind corners, shrubs, trees or other objects that may obscure vision.

2 *safety rules regarding outdoor power equipment (cont.)*

SLOPE OPERATION

Slopes are a major factor related to loss-of-control and tip-over accidents, which can result in severe injury or death. All slopes require extra caution. If you cannot back up the slope, or if you feel uneasy on it, do not drive on it.

Do

- Mow across the face of slopes; never up and down.
- Remove obstacles such as rocks, tree limbs, etc.
- Watch for holes, ruts, or bumps. Uneven terrain could overturn the unit. Tall grass can hide obstacles.
- Use slow speed. Choose a slow speed so that you will not have to stop or change speed while on the slope.
- Use extra care with grass catchers or other attachments. These can change the stability of the unit.
- Keep all movement on the slopes slow and gradual. Do not make sudden changes in speed or direction.

Do Not

- Do not start or stop on a slope. If tires lose traction, disengage the blade and proceed slowly straight down the slope.
- Do not turn on slopes unless necessary, and then, turn slowly and gradually downhill, if possible.
- Do not mow near drop-offs, ditches, or embankments. The operator could lose footing or balance or mower could suddenly turn over if a wheel is over the edge of a cliff or ditch, or if an edge caves in.
- Do not mow on wet grass. Reduced footing or traction could cause sliding.
- Do not mow excessively steep slopes.
- Do not use grass catcher on steep slopes.

CHILDREN

Tragic accidents can occur if the operator is not alert to the presence of children. Children are often attracted to the unit and the mowing activity. Never assume that children will remain where you last saw them.

- Keep children out of the mowing area and under the watchful care of another responsible adult.
- Be alert and turn unit off if children enter the area.
- Before and during reverse operation, look behind and down for small children.
- Never carry children. They may fall off and be seriously injured or interfere with safe unit operation.
- Never allow children to operate the unit.

- Use extra care when approaching blind corners, shrubs, trees, or other objects that may obscure vision.

EMISSIONS

- Engine exhaust from this product contains chemicals known, in certain quantities, to cause cancer, birth defects, or other reproductive harm.
- Look for the relevant Emissions Durability Period and Air Index information on the engine emissions label.

MAINTENANCE AND STORAGE

- Always observe safe refueling and fuel handling practices when refueling the unit after transportation or storage.
- Always follow the engine manual instructions for storage preparations before storing the unit for both short and long term periods.
- Always follow the engine manual instructions for proper start-up procedures when returning the unit to service.
- Never store the machine or fuel container inside where there is an open flame, such as in a water heater. Allow unit to cool before storing.
- Shut off fuel while storing or transporting. Do not store fuel near flames or drain indoors.
- Keep all hardware, especially blade attachment bolts, tight and keep all parts in good working condition. Replace all worn or damaged decals.
- Never tamper with safety devices. Check their proper operation regularly.
- Clean grass and debris from cutting units, drives, mufflers, and engine to prevent fires. Clean up oil or fuel spillage.
- Stop and inspect the equipment if you strike an object. Repair, if necessary, before restarting.
- Never make adjustments or repairs with the engine running unless specified otherwise.
- Park machine on level ground. Never allow untrained personnel to service machine.
- Use jack stands to support components when required.
- Carefully release pressure from components with stored energy. (e.g. springs)
- Use care when checking blades. Wrap the blade(s) or wear gloves, and use caution when servicing them. Only replace blades. Never straighten or weld them.
- Keep hands and feet away from moving parts.
- Grass catcher components are subject to wear, damage, and deterioration, which could expose moving parts or allow objects to be thrown. Frequently check components and replace with manufacturer's recommended parts, when necessary.

2 *safety rules regarding outdoor power equipment (cont.)*

- Check brake operation frequently. Adjust and service as required.
- Use only factory authorized replacement parts when making repairs.
- Always comply with factory specifications on all settings and adjustments.
- Only authorized service locations should be utilized for major service and repair requirements.
- Never attempt to make major repairs on this unit unless you have been properly trained. Improper service procedures can result in hazardous operation, equipment damage and voiding of manufacturer's warranty.

3 *assembly & installation*



IMPORTANT NOTE: Always stop engine and remove spark plug wire and all battery connections before attempting to remove or install any outdoor power equipment component or accessory.



IMPORTANT NOTE: In order to install your new mulching kit, it is necessary to: 1) lock both left and right brake handles (see mower operator's manual); 2) prop up the front end of your mower to gain access to the cutting blades. Use a floor jack or other stable form of support. Failure to do this can cause severe personal injury or death, as well as equipment damage.

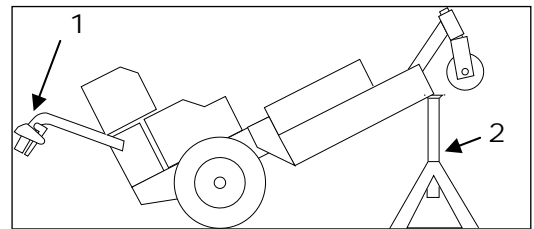

BLADE DECK HOOD REMOVAL

- Pull rubber T-straps up and away from cupped brackets on side of blade deck hood.
- Carefully lift blade deck hood off of mower deck and set aside.

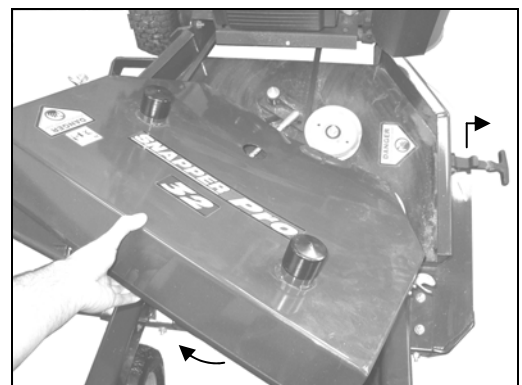

3 *assembly & installation (cont.)*

 **IMPORTANT NOTE:** Always stop engine and remove spark plug wire and all battery connections before attempting to remove or install any outdoor power equipment component or accessory.

MULCHING BLADE INSTALLATION

- Using two 15/16" wrenches, one on blade bolt nut atop blade spindle, and one on blade bolt beneath, loosen blade bolt assembly (pneumatic tools may be required). (Note: Blade bolt is standard right-hand thread.)

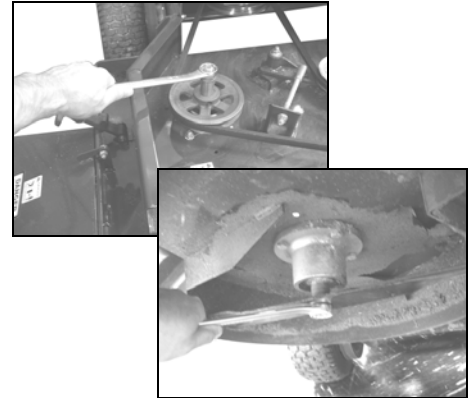

- Supporting blade bolt from beneath, remove blade bolt nut and spacers from atop blade spindle and set aside. (Note: Carefully note number of spacers, in order to correctly reassemble blade bolt assembly later.)
- Carefully slip blade bolt out from bottom of blade spindle.

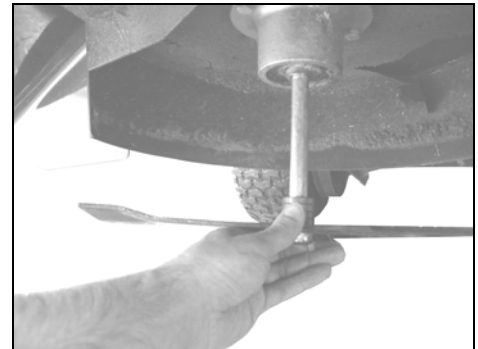

- Slip spacers off blade bolt and set aside, carefully noting number of spacers for correct reassembly.
- Remove blade from bolt, replacing with mulching blade. (NOTE: Be sure mulching teeth are facing up toward bolt thread as shown.)
- Replace spacers removed in previous step.

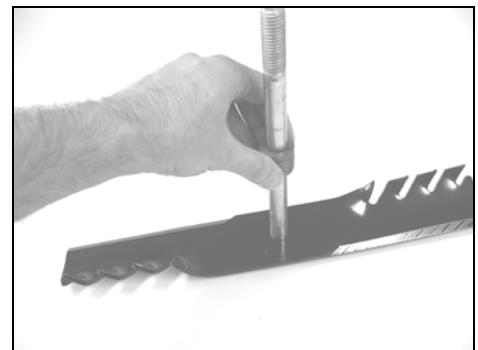

3 *assembly & installation (cont.)*



IMPORTANT NOTE: Always stop engine and remove spark plug wire and all battery connections before attempting to remove or install any outdoor power equipment component or accessory.

MULCHING BLADE INSTALLATION (cont.)

- Slip blade assembly back up through blade spindle, and secure with spacers and nut removed in previous step.
- Torque blade bolt to 179 ft. lbs.
- Repeat all previous steps for second blade assembly.
- Replace Blade Deck Hood, securing with rubber T-straps.



DISCHARGE COVER INSTALLATION

- Using two ½” wrenches, remove hardware securing Discharge Deflector from right side of mower. (Helpful Hint – After removal of deflector, replace hardware in hinge tabs of deflector, tighten finger tight, and set deflector aside with standard cutting blades removed in previous step.



- Lay Discharge Cover against discharge side of mower, aligning holes in cover with corresponding threaded holes in discharge accessory bar (foremost hole in rear set of holes, rearmost hole in front set of holes).
- Secure cover with two 3/8-16 x ¾” hex bolts, each fitted with one 3/8” split lock washer. Tighten securely.

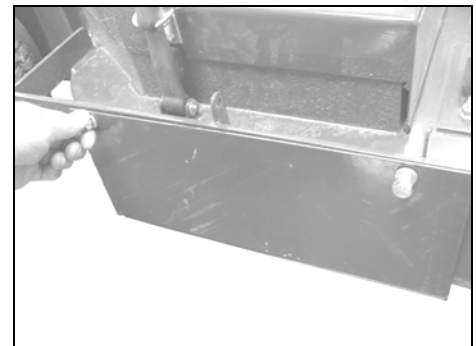

3 *assembly & installation (cont.)*

Installation is complete. Reconnect spark plug wire and battery connections, and refer to the operating instructions furnished with your mower for starting and operating instructions.

4 *operation*

GENERAL GUIDELINES TO OBSERVE BEFORE OPERATION

- Be sure that all kit components, as well as all mower components themselves, are in good working condition. Always check for worn, bent or broken blades, broken or worn belts, loose fasteners, etc. NEVER OPERATE DEFECTIVE EQUIPMENT – CONTACT YOUR LOCAL DEALER FOR REPLACEMENT PARTS OR SERVICE.
- Be sure that all kit components are completely assembled and installed as per instructions.
- Be sure that all tools, removed mower components, and other materials left over from installation have been removed completely from the work area.
- Be sure to wear appropriate personal protective equipment – eye, ear and breathing protection is a must.
- Prepare the area before operation by manually removing any debris, such as branches, twigs, etc, that may cause damage to the blades or deck.

OPERATION

- Begin mowing as you normally would. Within a minute or two, you should begin to see a layer of finely chopped mulch left behind on the cut grass as you mow.
- While mowing, listen for sudden or gradual changes in engine pitch, or look for a sudden absence of mulch, either of which may indicate clogging of deck or blades. IMMEDIATELY shut the unit down and refer to the maintenance section of this manual.

5 *maintenance & troubleshooting*

MAINTENANCE

With your mulching kit installed, your mower now acts as a mulching mower. A mulching mower performs differently from a standard mower.

A standard mower is designed to merely cut grass, then lift the clippings into a series of directional vanes in the underside of the blade deck that route the clippings through the discharge deflector and out from the mower.

A mulching mower (also referred to as a *recycling* mower) is designed to first cut grass, then pulverize the clippings as they are lifted into the deck. With the discharge covered, the clippings simply circulate in the deck, recycled through the serrated blades that break down the clippings into a rich pulp (mulch) whose nutrients can be easily absorbed into the soil. The pulp is then deposited to the ground beneath, where it becomes an instant fertilizer.

5 maintenance & troubleshooting (cont.)

The benefits of mulching are obvious: free fertilizer, and no raking. But take into account that in the recycling of grass clippings, a buildup of pulp may occur both in the underside of the deck and in the serrated teeth of the mulching blades. Therefore, a periodic inspect of the underside of the mower after each use is recommended, as a buildup of pulp can affect mower performance. If necessary, clean out the deck and the blade teeth. Always use a stick or some other device to remove buildup from blades and deck – never use fingers – sharp edges hidden in or behind buildup may cause injury.



IMPORTANT NOTE: Always stop engine and remove spark plug wire and all battery connections before attempting to service any outdoor power equipment.

OTHER GENERAL MAINTENANCE ITEMS

- Check components often for wear and breakage; repair or replace promptly. Contact your dealer for genuine replacement parts.
- Remove the mulching kit from the mower when not in use, replacing the mower's original components to prevent personal injury or damage to the mower. Do not use the mulching blades without the discharge cover in place; conversely, do not use the mulching discharge cover with standard blades.
- An occasional washing with warm soapy water will keep the mulching kit components looking and performing their best. Dry components thoroughly after washing.
- Store the mulching kit in a cool, dry place.

TROUBLESHOOTING CHART

Problem	Possible cause	Remedy
Blades not cutting	Mower engine not running	Start engine
	Blades not engaged	Engage blades
	Deck/blades clogged	Turn unit off, disconnect spark plug and battery connections, check & clear deck and blades as needed
	Blades dull	Bring blades to authorized dealer for resharpening or replacement
	Blades installed upside-down	Check blade installation; reinstall if necessary
	Mower problem	Refer to troubleshooting guide in mower manual
Blades cutting poorly	Blades dull	Bring blades to authorized dealer for resharpening or replacement
	Blades installed upside-down	Check blade installation; reinstall if necessary
Unit not mulching	Discharge cover not installed	Install discharge cover
	Deck/blades clogged	Turn unit off, disconnect spark plug and battery connections, check & clear deck and blades as needed
	Blades dull	Bring blades to authorized dealer for resharpening or replacement

6 parts list

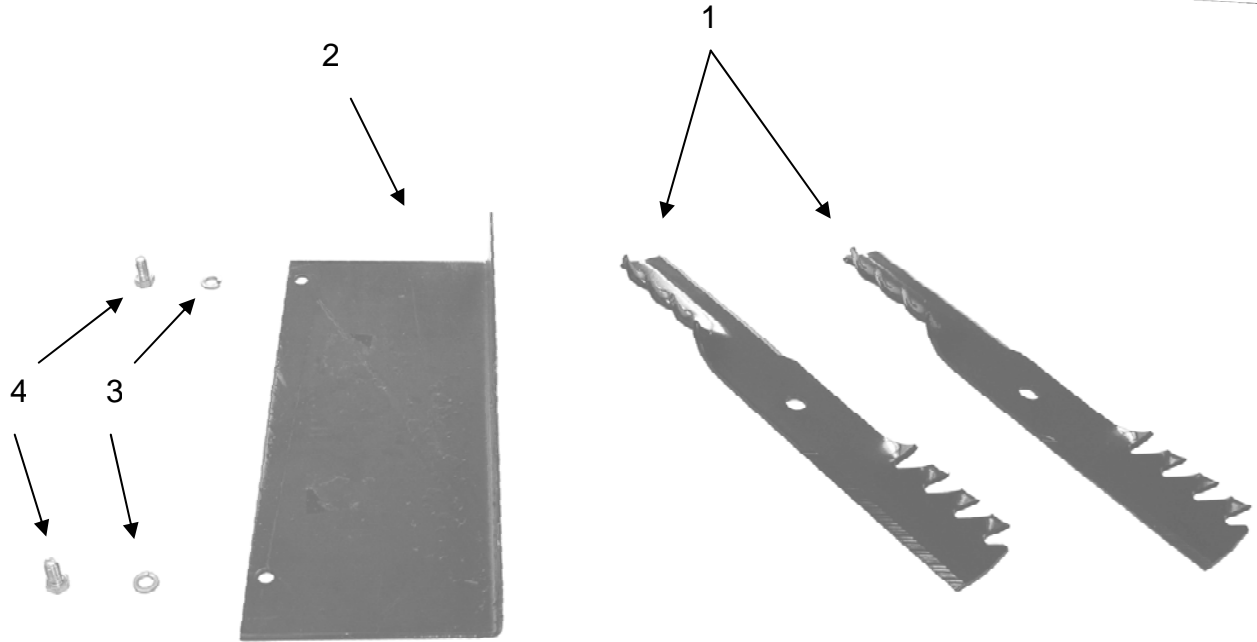

Parts List for MK32 Mulch Kit (Kit #3070946)			
Ref #	Description	Qty	Part #
1	Mulching Blade – 16"	2	3021569
2	Discharge Cover	1	3024638
3	3/8" Split Lock Washer	2	90118
4	3/8-16 x 3/4" Hex Bolt	2	90134



GIANT-VAC®

535 MACON ROAD
McDONOUGH, GA 30253

3072493
R0404.1