

SCAG[®]

POWER EQUIPMENT

OPERATOR'S MANUAL

CLASSIC Wheeled Blower

Model: LBC15-BS950



Congratulations on owning a Scag wheeled blower! This manual contains the operating instructions and safety information for your Scag wheeled blower. Reading this manual can provide you with assistance in maintenance and adjustment procedures to keep your blower performing to maximum efficiency. The specific models that this book covers are listed on the inside cover. Before operating your blower, please read all the information enclosed.



WARNING

FAILURE TO FOLLOW SAFE OPERATING PRACTICES MAY RESULT IN SERIOUS INJURY OR DEATH.

- Read this manual completely as well as other manuals that came with your blower.
- ALWAYS FOLLOW OSHA APPROVED OPERATION.
- Become familiar with the safe operation of the equipment, operator controls and safety signs.
- DO NOT operate on steep slopes.
- Always travel across slopes.
- Keep all shields in place, especially the discharge chute.
- Before performing any maintenance or service, stop the machine and remove the spark plug wire.
- If a mechanism becomes clogged, stop the engine before cleaning.
- Keep hands, feet and clothing away from power-driven parts.

REMEMBER - YOUR BLOWER IS ONLY AS SAFE AS THE OPERATOR!

HAZARD CONTROL AND ACCIDENT PREVENTION ARE DEPENDENT UPON THE AWARENESS, CONCERN, PRUDENCE, AND PROPER TRAINING OF THE PERSONNEL INVOLVED IN THE OPERATION, TRANSPORT, MAINTENANCE, AND STORAGE OF THE EQUIPMENT.

This manual covers the operating instructions and illustrated parts list for:

LBC15-BS950

with a serial number of

P4400001 to P4499999

Always use the entire serial number listed on the serial number tag when referring to this product.

Table of Contents

SECTION 1 - GENERAL INFORMATION.....	1
1.1 INTRODUCTION.....	1
1.2 DIRECTION REFERENCE	1
1.3 SERVICING THE ENGINE AND DRIVE TRAIN COMPONENTS.....	1
1.4 SYMBOLS	2
SECTION 2 - SAFETY INFORMATION	3
2.1 INTRODUCTION.....	3
2.2 SIGNAL WORDS	3
2.3 BEFORE OPERATION CONSIDERATIONS.....	3
2.4 OPERATION CONSIDERATIONS.....	4
2.5 MAINTENANCE CONSIDERATIONS & STORAGE	5
2.6 USING A SPARK ARRESTOR.....	5
2.7 SPARK IGNITION SYSTEM	5
2.8 SAFETY AND INSTRUCTIONAL DECALS	6
SECTION 3 - SPECIFICATIONS	7
3.1 ENGINE	7
3.2 BLOWER	7
3.3 WEIGHTS AND DIMENSIONS.....	7
SECTION 4 - OPERATING INSTRUCTIONS	9
4.1 CONTROLS AND INSTRUMENT IDENTIFICATION	9
4.2 INITIAL RUN-IN PROCEDURES.....	9
4.3 STARTING THE ENGINE	10
4.4 HILLSIDE OPERATION.....	10
4.5 PARKING THE BLOWER	10
4.6 AFTER OPERATION	10
4.7 REMOVING CLOGGED MATERIAL	11
4.8 RECOMMENDATIONS FOR BLOWING	11

SECTION 5 - MAINTENANCE	12
5.1 MAINTENANCE CHART - RECOMMENDED SERVICE INTERVALS	12
5.2 ENGINE OIL	13
5.3 ENGINE FUEL SYSTEM	13
5.4 ENGINE AIR CLEANER.....	13
5.5 TIRES.....	13
SECTION 6 - ILLUSTRATED PARTS LIST	14
6.1 SCAG APPROVED ATTACHMENTS AND ACCESSORIES.....	14
NOTES.....	15
CLASSIC BLOWER ASSEMBLY	16
CLASSIC BLOWER DECALS.....	18
SECTION 7 - LIMITED WARRANTY - CLASSIC WHEELED BLOWER	INSIDE BACK COVER

GENERAL INFORMATION

1.1 INTRODUCTION

Your Scag product was built to the highest standards in the industry. However, the prolonged life and maximum efficiency of your blower depends on you following the operating, maintenance and adjustment instructions in this manual.

If additional information or service is needed, contact your Scag Power Equipment Dealer.

We encourage you to contact your dealer for repairs. All Scag dealers are informed of the latest methods to service this equipment and provide prompt and efficient service in the field or at their service shop. They carry a full line of Scag service parts.

- IMPORTANT -

The replacement of any part on this product by other than the manufacturer's authorized replacement part may adversely affect the performance, durability or safety of this product.

Use of other than original Scag replacement parts will void the warranty.

When ordering parts, always give the model and serial number of your product. The serial number plate is located on the frame next to the engine.

USE ONLY SCAG APPROVED ATTACHMENTS AND ACCESSORIES.

Attachments and accessories manufactured by companies other than Scag Power Equipment are not approved for use on this machine. See Section 6-1.

WARNING

For pictorial clarity, some illustrations and figures in this manual may show shields, guards or plates open or removed. Under no circumstances should this product be operated without these devices in place.

All information is based upon product information available at the time of approval for printing. Scag Power Equipment reserves the right to make changes at any time without notice and without incurring any obligation.













1.2 DIRECTION REFERENCE

The "Right" and "Left", "Front" and "Rear" of the machine are referenced from the operator's right and left when in the normal operating position and facing the forward travel direction.

1.3 SERVICING THE ENGINE AND DRIVE TRAIN COMPONENTS

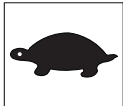
Details regarding the service and repair of the engine are not covered in this manual; only routine maintenance and general service instructions are provided. For service of these components during the limited warranty period, it is important to contact your Scag dealer or find a local authorized servicing agent of the component manufacturer. Any unauthorized work done on these components during the warranty period may void your warranty.

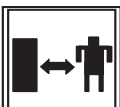
1.4 SYMBOLS

SYMBOL	DESCRIPTION	SYMBOL	DESCRIPTION
	Choke		Transmission
	On/Start		Spring Tension on Idler
	Off/Stop		Oil
	Spinning Fan Blades		Thrown Object Hazard
	Fast		Slow
	Continuously Variable - Linear		Pinch Point
	Keep Bystanders Away		Read Operator's Manual

SAFETY INFORMATION

2.1 INTRODUCTION

Your blower is only as safe as the operator. Carelessness or operator error may result in serious bodily injury or death. Hazard control and accident prevention are dependent upon the awareness, concern, prudence, and proper training of the personnel involved in the operation, transport, maintenance and storage of the equipment. Make sure every operator is properly trained and thoroughly familiar with all of the controls before operating. The owner/user can prevent and is responsible for accidents or injuries occurring to themselves, other people or property.

READ THIS OPERATOR'S MANUAL BEFORE ATTEMPTING TO START YOUR BLOWER.

A replacement manual is available from your authorized Scag Service Dealer or by contacting Scag Power Equipment, Service Department at P.O. Box 152, Mayville, WI 53050 or contact us via the Internet at www.scag.com. The manual for this machine can be downloaded by using the model and serial number or use the contact form to make your request. Please indicate the complete model and serial number of your Scag product when requesting replacement manuals.

2.2 SIGNAL WORDS



This symbol means "**Attention! Become Alert! Your Safety is Involved!**" The symbol is used with the following signal words to attract your attention to safety messages found on the decals on the machine and throughout this manual. The message that follows the symbol contains important information about safety. To avoid injury and possible death, carefully read the message! Be sure to fully understand the causes of possible injury or death.

SIGNAL WORD:

It is a distinctive word found on the safety decals on the machine and throughout this manual that alerts the viewer to the existence and relative degree of the hazard.

DANGER

The signal word "DANGER" denotes that an extremely hazardous situation exists on or near the machine that could result in high probability of death or irreparable injury if proper precautions are not taken.

WARNING

The signal word "WARNING" denotes that a hazard exists on or near the machine that can result in injury or death if proper precautions are not taken.

CAUTION

The signal word "CAUTION" is a reminder of safety practices on or near the machine that could result in personal injury if proper precautions are not taken.

Your safety and the safety of others depends significantly upon your knowledge and understanding of all correct operating practices and procedures of this machine.

2.3 BEFORE OPERATION CONSIDERATIONS

1. NEVER allow children to operate this machine. Do not allow adults to operate this machine without proper instructions.
2. Do not operate when children and/or others are present. Keep children out of the work area and in the watchful care of a responsible adult other than the operator. Be alert and turn machine off if a child enters the area.
3. DO NOT allow children to ride or play on the machine, it is not a toy.
4. DO NOT operate the machine under the influence of alcohol or drugs.
5. If the operator(s) or mechanic(s) cannot read English, it is the owner's responsibility to explain this material to them.

- DO NOT wear loose fitting clothing. Loose clothing, jewelry or long hair could get tangled in moving parts. Do not operate the machine wearing shorts; always wear adequate protective clothing including long pants. Wearing safety glasses, safety shoes and a helmet is advisable and is required by some local ordinances and insurance regulations.



WARNING

Always wear hearing protection. Operating this machine over prolonged periods of time can cause loss of hearing.

- Keep the machine and attachments in good operating condition. Keep all shields and safety devices in place. If a shield, safety device or decal is defective or damaged, repair or replace it before operating the machine.
- Fuel is flammable; handle it with care. Fill the fuel tank outdoors. Never fill it indoors. Use a funnel or spout to prevent spillage. Clean up any spillage before starting the engine.
- DO NOT add fuel to a running or hot engine. Allow the engine to cool for several minutes before adding fuel. Never fuel indoors or inside enclosed trailers.
- See Section 5.3 ENGINE FUEL SYSTEM for fueling procedure.
- Keep flammable objects (cigarettes, matches, etc.), open flames and sparks away from the fuel tank and fuel container. Use only approved containers.
- Do not operate without the side deflector installed.
- Check the engine mounting bolts at frequent intervals for proper tightness.

2.4 OPERATION CONSIDERATIONS

- Know the function of all controls and how to stop quickly.
- Do not operate on slopes if you are uneasy or uncertain. Ultimate responsibility for safe operation on slopes rests with the operator.
- Exercise extreme caution when operating on slopes. Keep all movements slow and gradual. Be sure of your footing.
- Do not turn on slopes unless absolutely necessary. Turn slowly and downhill when possible.
- Do not operate on steep slopes. Poor footing could cause a slip and fall accident.
- When using this machine, never direct the blown material toward bystanders or allow anyone near the machine while in operation.
- Do not blow material towards cars, windows, or other items which could be injured or damaged by blown debris.
- Before attempting to start the engine, inspect the machine, shields and safety devices for any damage. Correct any problems before operating.
- If the blower ever plugs, shut off the engine, and wait for all movement to stop before removing the obstruction.



WARNING

DO NOT use your hand to dislodge the clogged material. Use a stick or other device to remove clogged material after the engine has stopped running and the blower fan have stopped turning.

- If the machines begins to vibrate abnormally, shut the machine off immediately. Inspect the machine and have repairs made before restarting.
- Be alert for holes, rocks, roots and other hidden hazards in the terrain. Cautiously enter a new area. Be alert for hidden hazards.
- Do not operate near drop-offs, ditches or embankments. You could lose your footing, balance or drive the machine off the edge.

Section 2

13. Use only in daylight or good artificial light.
14. Do not leave the machine unattended.
15. The machine and attachments should be stopped and inspected for damage after striking a foreign object, and damage should be repaired before restarting and operating the machine.
16. Keep hands and feet away from blower intake and outlet. Contact can injure.

CAUTION

Do not touch the engine or the muffler while the engine is running or immediately after stopping. These areas may be hot enough to cause a burn.

DANGER

DO NOT run the engine inside a building or a confined area without proper ventilation. Exhaust fumes are hazardous and contain carbon monoxide which can cause brain injury and death.

17. Keep hands and feet away from all other moving parts. Contact can injure.
18. Use extra care when loading or unloading the machine into a truck or trailer.
19. Tie the blower down securely using straps, chains, cable, or ropes. Both front and rear straps must be directed down and outward from machine.
20. Use care when approaching blind corners, shrubs, trees, or other objects that may obscure vision.
21. NEVER leave the machine running unattended.

2.5 MAINTENANCE CONSIDERATIONS & STORAGE

1. Never make adjustments to the machine with the engine running unless specifically instructed to do so. If the engine is running, keep hands, feet, and clothing away from moving parts.

2. Do not straighten or weld the blower fan. Replace damaged or failed blower fans.
3. Disconnect spark plug wire to prevent accidental starting of the engine when servicing or adjusting the machine. Wait for all movement to stop before adjusting, cleaning or repairing.
4. Keep all nuts, bolts and screws tight, to ensure the machine is in safe working condition.
5. Do not change the engine governor settings or overspeed the engine. See the engine operator's manual for information on engine settings.
6. To reduce fire hazard, keep the muffler and engine free of grass, leaves, excessive grease, oil and dirt.
7. Park the machine on level ground.
8. NEVER allow untrained personnel to service the machine.
9. Keep all parts in good working condition. Replace all worn or damaged decals.
10. Use jack stands to support components when required.
11. Let the engine cool before storing.
12. DO NOT store the machine near an open flame.
13. Shut off fuel while storing or transporting.
14. DO NOT store fuel near flames or drain indoors.

2.6 USING A SPARK ARRESTOR

The engine in this machine is not equipped with a spark arrestor muffler. It is in violation of California Public Resource Code Section 4442 to use or operate this engine on or near any forest covered, brush covered or grass covered land unless the exhaust system is equipped with a spark arrestor meeting any applicable local or state laws. Other states or federal areas may have similar laws. Check with your state or local authorities for regulations pertaining to these requirements.

2.7 SPARK IGNITION SYSTEM

This spark ignition system complies with Canadian ICES-002.

2.8 SAFETY AND INSTRUCTIONAL DECALS

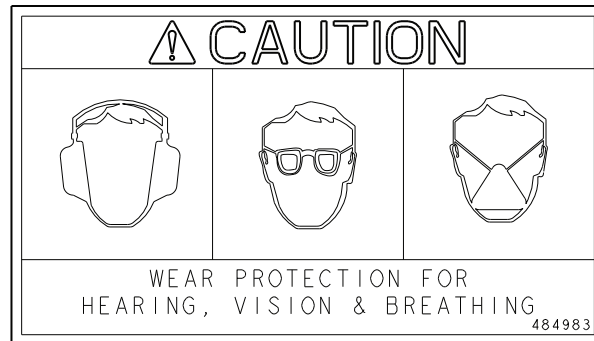

484983

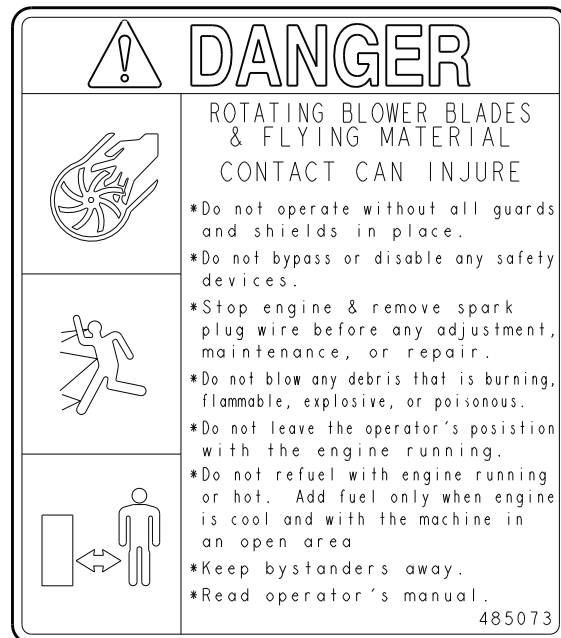

485073

SPECIFICATIONS**3.1 ENGINE**

General TypeHeavy Duty Industrial/Commercial Gasoline
 BrandBriggs & Stratton
 Engine Model:
 (Scag LBC15-BS950) Briggs & Stratton Model # BS950
 Displacement:
 Briggs & Stratton BS950 208cc
 Cylinders..... 1 with Cast-Iron Sleeve
 Governor.....Centrifugal Flywheel Type Set to 3,600 RPM at maximum load (+/- 100 RPM)
 Idle Speed 1,450 RPM (+ 200 /- 150 RPM)
 CarburetorFloat Type
 Fuel..... Non-Leaded Gasoline with a Minimum Octane Rating of 87
 Fuel Capacity..... 0.8 Gallon (3.0L)
 Lubrication Type..... Mechanical Splash Type
 Oil Capacity0.63 Quart (0.6L)
 Starter Recoil Starter
 Ignition SystemSolid State Transistorized Magneto
 Air Filter Dual Element

3.2 BLOWER

Impeller DiameterBalanced 15" Steel
 Number of Blades..... 4
 CFM (cubic feet / min.) 1392
 Discharge Control.....Front / Side

3.3 WEIGHTS AND DIMENSIONS

Length.....43"
 Width27"
 Height40"
 Weight 105#
 Wheels:
 (1) Front..... 6 X 1.50 Semi-Pneumatic
 (2) Rear4.10 X 3.50-4 Two-Ply Pneumatic Tubeless, Radius Edge
 Tire Pressure:
 Rear..... 20 PSI

OPERATING INSTRUCTIONS

CAUTION

Do not attempt to operate this blower unless you have read this manual. Learn the location and purpose of all controls and instruments before you operate.

4.1 CONTROLS AND INSTRUMENT IDENTIFICATION

Before operating the blower, familiarize yourself with all blower and engine controls. Knowing the location, function and operation of these controls is important for safe and efficient operation.

1. **Ignition Switch (Figure 4-1).** The ignition switch is used to start the engine. Turn the knob to the on position before pulling the recoil starter.

2. **Engine Choke Control (Figure 4-1).** Used to start a cold engine.
3. **Engine Throttle Control (Figure 4-1).** Used to control the engine speed. Pushing the lever forward increases engine speed. Pulling the lever back decreases engine speed. Full back position is the IDLE position.
4. **Fuel Control Lever (Figure 4-1).** Used to control the fuel supply to the engine.

4.2 INITIAL RUN-IN PROCEDURES

FIRST DAY OF USE OR APPROXIMATELY 20 HOURS

1. Change the engine oil and oil filter after the first 20 hours of operation. (See Section 5.2.)
2. Check for loose hardware. Tighten as needed.
3. Check tire pressure. Adjust pressure if necessary. (See Section 5.5.)

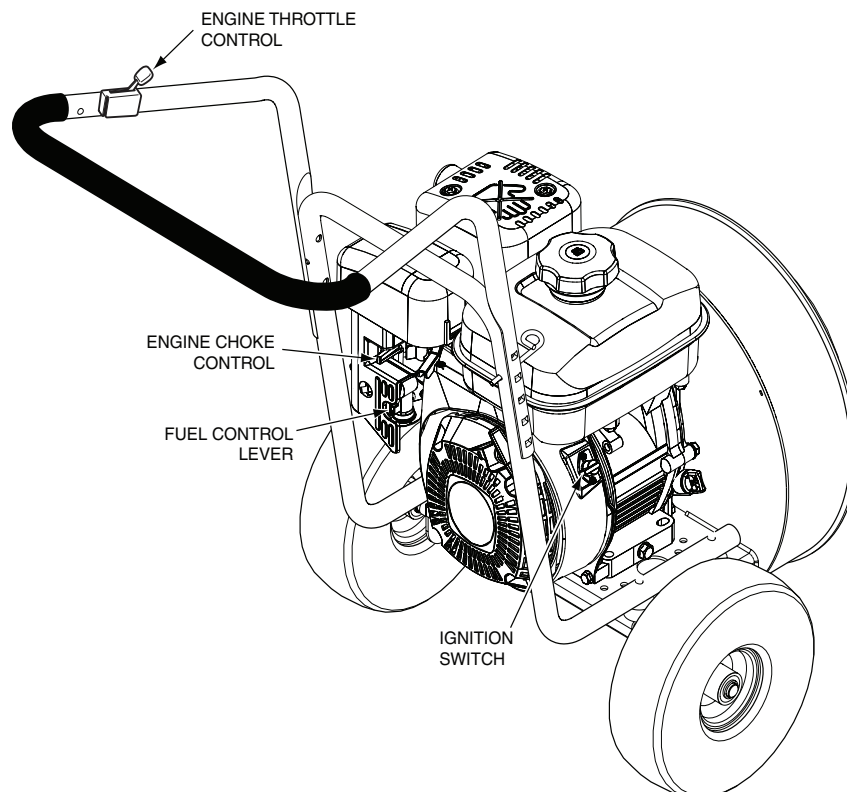

Figure 4-1. Controls and Instruments

4.3 STARTING THE ENGINE

CAUTION

DO NOT USE STARTING FLUIDS. Use of starting fluids in the air intake system may be potentially explosive or cause a “runaway” engine condition that could result in engine damage and/or personal injury.

1. Be sure the fuel control lever, located on the left side of the engine, is completely open. See Figure 4-1.
2. If the engine is cold, choke the engine as needed.
3. Move the engine throttle control to about half engine speed.
4. Turn the ignition switch to the ON position.
5. Pull the recoil starter on the engine.
6. Allow engine to warm before operating the blower.

4.4 HILLSIDE OPERATION

WARNING

DO NOT operate on steep slopes. Poor footing could cause a slip and fall accident. ALWAYS FOLLOW OSHA APPROVED OPERATION.

1. Do not operate on slopes if you are uneasy or uncertain. Ultimate responsibility for safe operation on slopes rests with the operator.
2. Be sure of footing on slopes.
3. Caution must be used when operating on slopes, especially when the grass is wet. Wet grass reduces traction and control.
4. To prevent tipping or loss of control, keep all movements on slopes slow and gradual.
5. Do not turn on slopes unless necessary, and then turn slowly and down hill when possible.
6. Be alert for holes, rocks, roots and other hidden hazards in the terrain. Uneven terrain could cause a slip and fall accident.
7. Keep tires properly inflated.

4.5 PARKING THE BLOWER

1. Park the machine on a flat, level surface only. Do not park the machine on an incline.
2. Slow the engine to idle speed.
3. Turn the ignition switch to the OFF position.

4.6 AFTER OPERATION

1. Wash the entire blower after each use. Do not use high pressure spray or direct the spray onto electrical components.

- IMPORTANT -

Do not wash a hot or running engine. Cold water will damage the engine. Use compressed air to clean the engine if it is hot.

2. Keep the entire blower clean to inhibit serious heat damage to the engine.
3. Check the tire pressure. Adjust pressure if necessary.

Section 4

4.7 REMOVING CLOGGED MATERIAL

DANGER

ROTATING FAN BLADES

NEVER PUT YOUR HANDS INTO THE AIR INTAKE OR OUTLET FOR ANY REASON!

Shut off the engine, remove the spark plug wire and only then use a stick or similar object to remove material if clogging has occurred.

1. If the air intake or outlet becomes clogged, shut off the engine and remove the spark plug wire. Using a stick or similar item, dislodge the clogged material. Then resume normal operation.

4.8 RECOMMENDATIONS FOR BLOWING

Air flow can be directed to the side or front by adjusting the two-position deflector. The front discharge position is used to remove debris from along retaining walls, fences, etc. The side discharge position to form windrows and/or piles. The air speed of the blower is regulated by the engine throttle.

1. To reduce windrowing or to blow over an obstacle, point the deflector upwards.

WARNING

DO NOT operate without Two-Position Deflector properly installed.

2. To avoid blowing into an area, close the deflector and reduce the throttle setting.
3. Plan how to clear a yard or parking lot to reduce clearing time.
4. Keep blower intake and outlet clean.
5. Use a slow travel speed when clearing heavy or large amounts of material.
6. Operate the engine at full throttle for best results. The engine is designed to be operated at full speed.

MAINTENANCE

5.1 MAINTENANCE CHART - RECOMMENDED SERVICE INTERVALS

BREAK-IN (FIRST 10)	HOURS						PROCEDURE	COMMENTS
	8	20	50	100	200	500		
X							Check all hardware for tightness	
	X						Check engine oil level	See engine operator's manual
	X						*Clean blower	
	X						Check tire pressure	
	X						Check condition of fan blades	
		X					Change engine oil and filter	See engine operator's manual
			X				*Clean air filter element	See engine operator's manual
				X			Check condition of fuel lines	
				X			Check all hardware for tightness	
				X			Change engine oil	See engine operator's manual
				X			*Clean air cleaner element	See engine operator's manual
					X		*Clean Fuel Cup	See engine operator's manual
					X		*Replace engine air filter	See engine operator's manual
					X		Clean and Adjust Spark Plug	See engine operator's manual
						X	Replace Spark Plug	See engine operator's manual

* Perform these maintenance procedures more frequently under extreme dusty or dirty conditions

Section 5

5.2 ENGINE OIL

A. CHECKING ENGINE CRANKCASE OIL LEVEL

The engine oil level should be checked after every 8 hours of operation or daily as instructed in the Engine Operator's Manual furnished with this blower.

B. CHANGING ENGINE CRANKCASE OIL

After the first 20 hours of operation, change the engine crankcase oil and replace the oil filter. Thereafter, change the engine crankcase oil after every 100 hours of operation or bi-weekly, whichever occurs first. Refer to the Engine Operator's Manual furnished with this blower for instructions.

5.3 ENGINE FUEL SYSTEM



To avoid injury from burns, allow the blower to cool before removing the fuel tank cap and refueling.

A. FILLING THE FUEL TANK

Fill the fuel tank at the beginning of each operating day. Fill to the top of the fuel filter screen (approximately 0.8 gallon) at the beginning of each operating day. Do not overfill. Use clean, fresh unleaded gasoline with a minimum octane rating of 87 and a maximum of 10% Ethanol.

DO NOT use E85 Fuel. Using E85 Fuel will cause severe damage to the engine.

To avoid personal injury or property damage, use extreme care in handling gasoline. Gasoline is extremely flammable and the vapors are explosive.

1. Extinguish all cigarettes, cigars, pipes and other sources of ignition.
2. Use only an approved gasoline container.
3. When filling the fuel tank, always use the fuel filter screen.

4. Never remove the gas cap or add fuel with the engine running. Allow the engine to completely cool before fueling.
5. Never fuel the machine indoors or in an enclosed trailer.
6. Never store the machine or fuel container where there is an open flame, spark or pilot light such as on a water heater or other appliances.
7. Never fill containers inside a vehicle or on a truck or trailer bed with a plastic liner. Always place containers on the ground away from your vehicle before filling.
8. Remove the machine from the truck or trailer and fuel on level ground. If this is not possible, then refuel the machine with a portable container, rather than from a gasoline dispenser nozzle.
9. Keep the nozzle in contact with the rim of fuel tank or container opening at all times until fueling is complete. Do not use a nozzle lock-open device.
10. If fuel is spilled on clothing, change clothing immediately and wash affected skin.
11. Replace gas cap and tighten securely.

5.4 ENGINE AIR CLEANER

A. CLEANING AND/OR REPLACING AIR CLEANER ELEMENT

For any air cleaner, the operating environment dictates the air cleaner service periods. Inspect and clean the air cleaner element after every 200 hours of operation or monthly, whichever occurs first and replace the element if required. Refer to the Engine Operator's Manual furnished with this blower for instructions.

- NOTE -

In extremely dusty conditions it may be necessary to check the element once or twice daily to prevent engine damage.

5.5 TIRES

Check the tire pressures after every 8 hours of operation or daily.

Caster Wheels 20 PSI

ILLUSTRATED PARTS LIST

6.1 SCAG APPROVED ATTACHMENTS AND ACCESSORIES.

Attachments and accessories manufactured by companies other than Scag Power Equipment are not approved for use on this machine.

NOTES

CLASSIC BLOWER ASSEMBLY

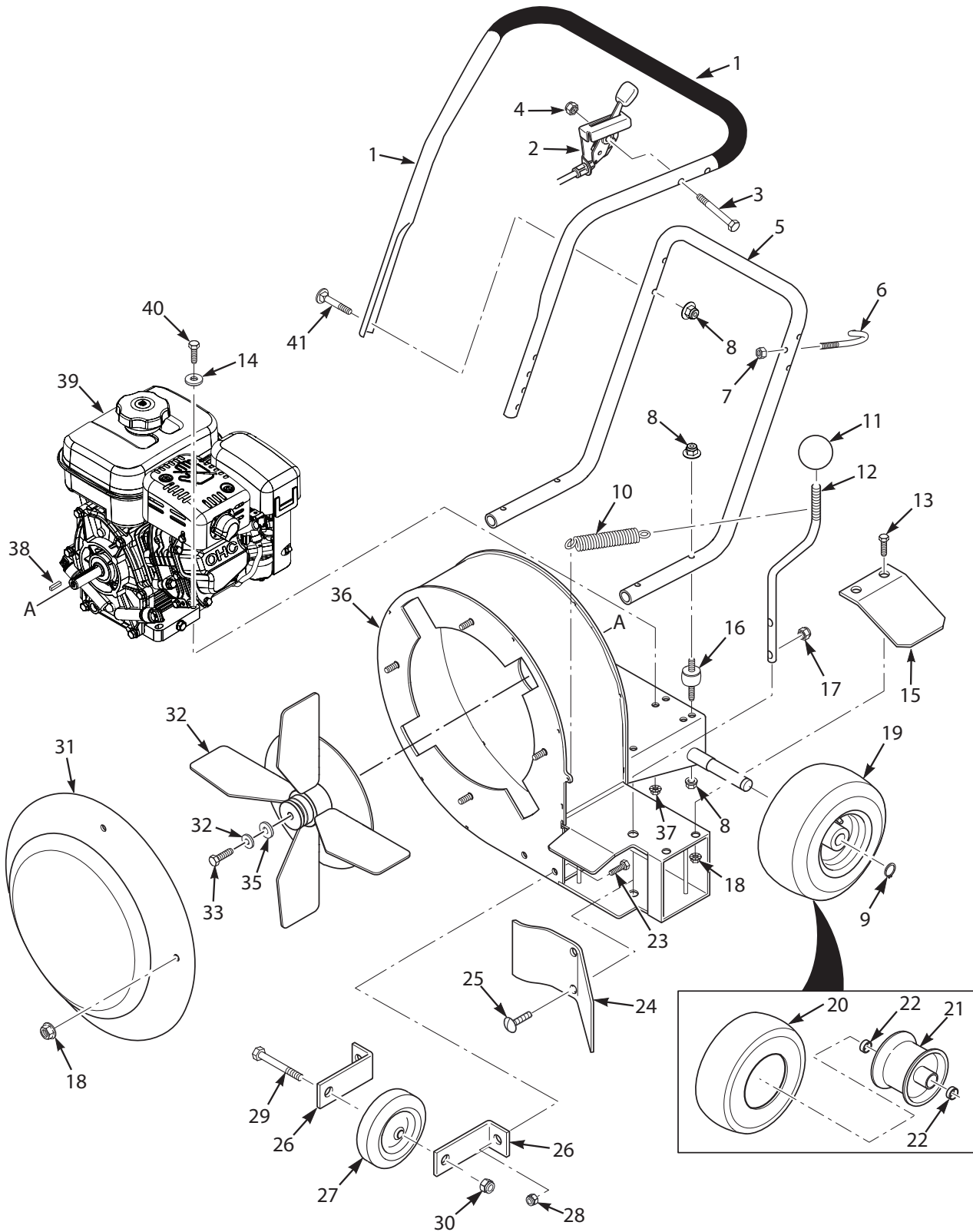

Section 6

CLASSIC BLOWER ASSEMBLY

Ref. No.	Part No.	Description
1	462618	Handle, Upper w / Grip - LBC
	485074	Grip, 1" x 25-1/2"
2	485006	Cable, Throttle Control
3	04001-206	Bolt, Hex Head 1/4-20 x 2-1/2"
4	04021-08	Nut, Elastic Stop 1/4-20
5	484928	Handle, Lower Folding - LBC
6	44200	Loop
7	04019-02	Nut, Serrated Flange 1/4-20
8	04117-01	Nut, Elastic Stop 5/16-18
9	04050-09	Retaining Ring
10	484764	Spring, Air Discharge Door
11	484840	Knob, Ball 3/8-16 Thread
12	44203	Rod, Air Control
13	04017-16	Bolt, Hex Head Serrated Flange 5/16-18 x 3/4"
14	04040-15	Flatwasher, 5/16-18 - .375 x .875 x .083
15	426339	Deflector, Side Air
16	484843	Mount, Vibration
17	04019-02	Nut, Serrated Flange 1/4-20
18	04019-03	Nut, Serrated Flange 5/16-18
19	484844	Wheel Assembly (incl. #20, 21, 22)
20	485008	Tire
21	485009	Rim w / Valve
22	485010	Bearing
23	04001-08	Bolt, Hex Head 5/16-08 x 3/4"
24	426341	Door, Forward Air Control
25	04003-02	Bolt, Carriage 1/4-20 x 3/4"
26	426169	Bracket, Caster
27	484845	Wheel
28	04117-01	Nut, Flange Elastic Stop Nut 5/16-18
29	04001-31	Bolt, Hex Head 3/8-16 x 2-1/2"
30	04021-09	Nut, Elastic Stop 3/8-16
31	463078	Baffle Weldment, Intake w / Decal
32	452878	Impeller Weldment, LBC 15 x 3/4" Bore
	04012-05	Setscrew, 1/4-20 x .50" (Not Shown)
33	04102-09	Bolt, Hex Head 5/16-24 x 2" w / Patch
34	04030-04	Lockwasher, 3/8" Spring
35	04041-11	Flatwasher, 3/8-.406 x 1.50 x 7 Ga.
36	462629	Blower Housing Weldment w / Decals - LBC
37	04117-01	Nut, Flange Elastic Stop 5/16-18
38	04063-05	Key, 3/16 x 3/16 x 1-1/2"
39	485893	Engine, Briggs & Stratton BS950 (not available through Scag Power Equipment)
40	04001-11	Bolt, Hex Head 5/16-18 x 1-1/2"
41	04003-15	Bolt, Carriage 5/16-18 x 1-3/4"

CLASSIC BLOWER DECALS



463079



48314

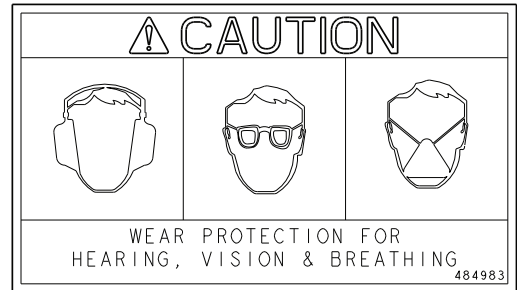

484983

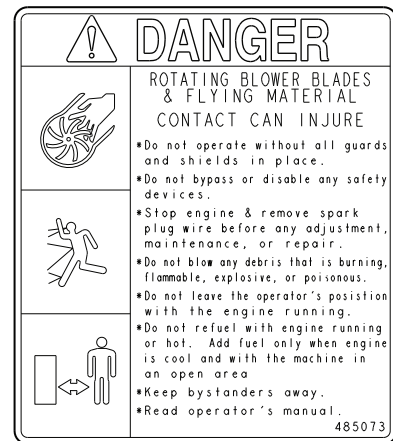

485073

LIMITED WARRANTY - CLASSIC WHEELED BLOWER

Any part of the Scag Classic Wheeled Blower manufactured by Scag Power Equipment and found, in the reasonable judgment of Scag, to be defective in materials or workmanship, will be repaired or replaced by an Authorized Scag Service Dealer without charge for parts and labor during the periods specified below. This warranty is limited to the original purchaser provided the product was purchased from an Authorized Scag Power Equipment Dealer and is not transferable. Proof of purchase will be required by the dealer to substantiate any warranty claims. All warranty work must be performed by an Authorized Scag Service Dealer.

This warranty is limited to the following specified periods from the date of the original retail purchase for defects in materials or workmanship:

- Wear items including bearings and tires are not included in this warranty.
- Fan Frame, blower housing, structural components including the handle assembly and throttle cable are warranted for one (1) year (parts and labor) for commercial use or two (2) years (parts and labor) for non-commercial use.
- Engines and electric starters are covered by the engine manufacturer's warranty period. Therefore, there are no warranties made, expressed or implied, for engines by Scag Power Equipment.
- Any Scag product used for rental purposes is covered by a 90 day warranty.

The Scag Classic Wheeled Blower, including any defective part must be returned to an Authorized Scag Service Dealer within the warranty period. The expense of delivering the blower to the dealer for warranty work and the expense of returning it to the owner after repair will be paid for by the owner. Scag's responsibility is limited to making the required repairs and no claim of breach of warranty shall be cause for cancellation or rescission of the contract of sale of any Scag blower. "Non-Commercial" use is defined as a single property owner, where the single property is the residence of the owner of the Scag blower. If the blower is used on more than the owners single property, it is deemed commercial use and the "non-commercial" warranty does not apply. Scag Power Equipment reserves the right to deny and / or void the non-commercial warranty if it believes it to be in commercial use.

This warranty does not cover any product that has been subject to misuse, neglect, negligence, or accident, or that has been operated in any way contrary to the operating instructions as specified in the Operator's Manual. The warranty does not apply to any damage to any wheeled blower that is the result of improper maintenance, or to any wheeled blower or parts that have not been assembled or installed as specified in the Operator's Manual and Assembly Manual. The warranty does not cover any wheeled blower that has been altered or modified, changing performance or durability. In addition, the warranty does not extend to repairs made necessary by normal wear, to items subject to abrasion wear, or by the use of parts or accessories which, in the reasonable judgment of Scag, are either incompatible with the Scag Classic Wheeled Blower or adversely affect its operation, performance or durability.

Scag Power Equipment reserves the right to change or improve the design of any product without assuming any obligation to modify any product previously manufactured. All other implied warranties are limited in duration to the one (1) year warranty commercial use, two (2) years for non-commercial use or ninety (90) days for wheeled blowers used for rental purpose. Accordingly, any such implied warranties including merchantability, fitness for a particular purpose, or otherwise, are disclaimed in their entirety after the expiration of the appropriate warranty period. Scag's obligation under this warranty is strictly and exclusively limited to the repair or replacement of defective parts and Scag does not assume or authorize anyone to assume for them any other obligation. Some states do not allow limitations on how long an implied warranty lasts, so the above limitation may not apply to you.

Scag assumes no responsibility for incidental, consequential or other damages including, but not limited to, expense for gasoline, expense of delivering the wheeled blower to an Authorized Scag Service Dealer and expense of returning it to the owner, mechanic's travel time, telephone or telegram charges, rental of a like product during the time warranty repairs are being performed, travel, loss or damage to personal property, loss of revenue, loss of use of the wheeled blower, loss of time or inconvenience. Some states do not allow the exclusion or limitation of incidental or consequential damages, so the above limitation or exclusion may not apply to you. This warranty gives you specific legal rights, and you may also have other rights which vary from state to state.